

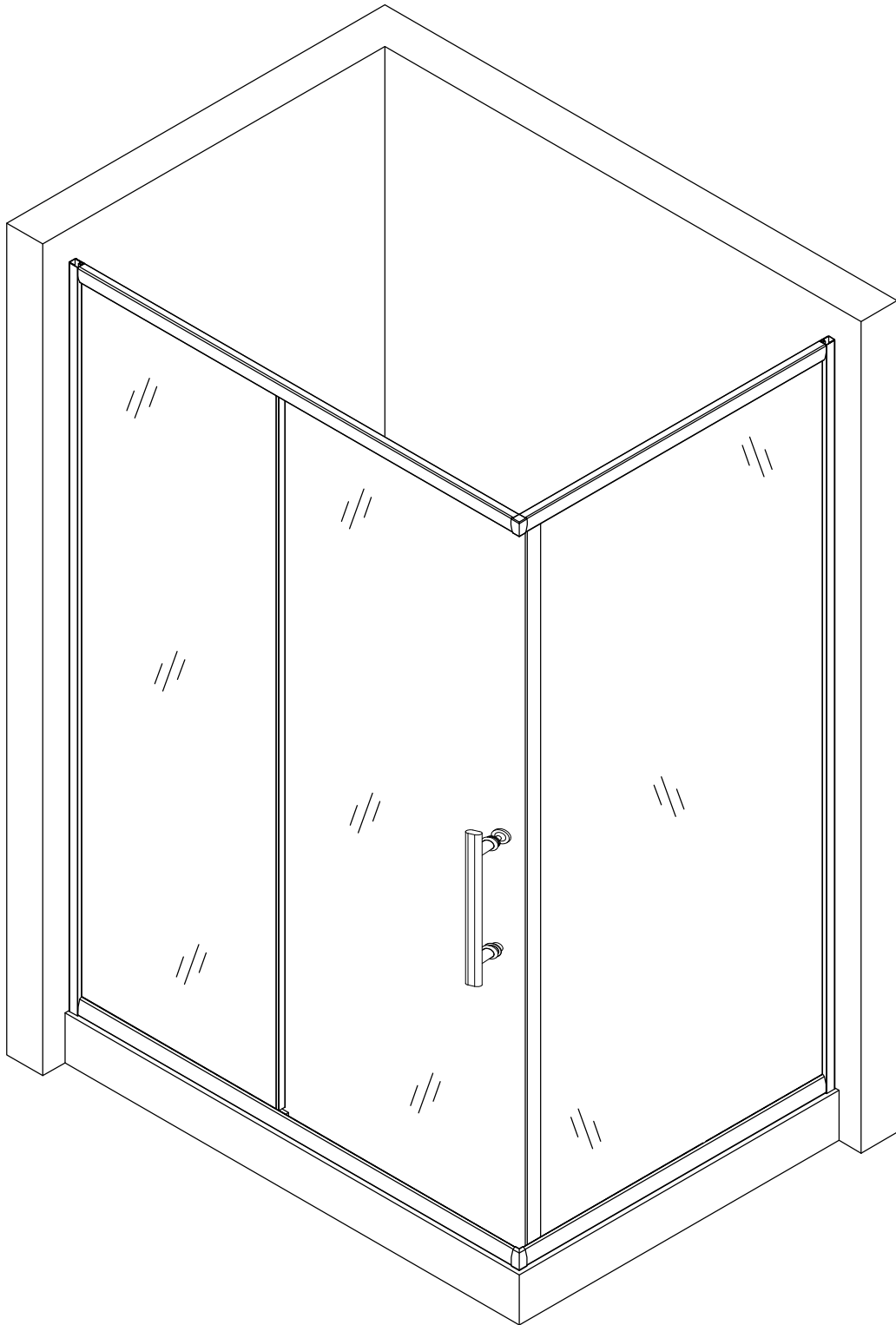

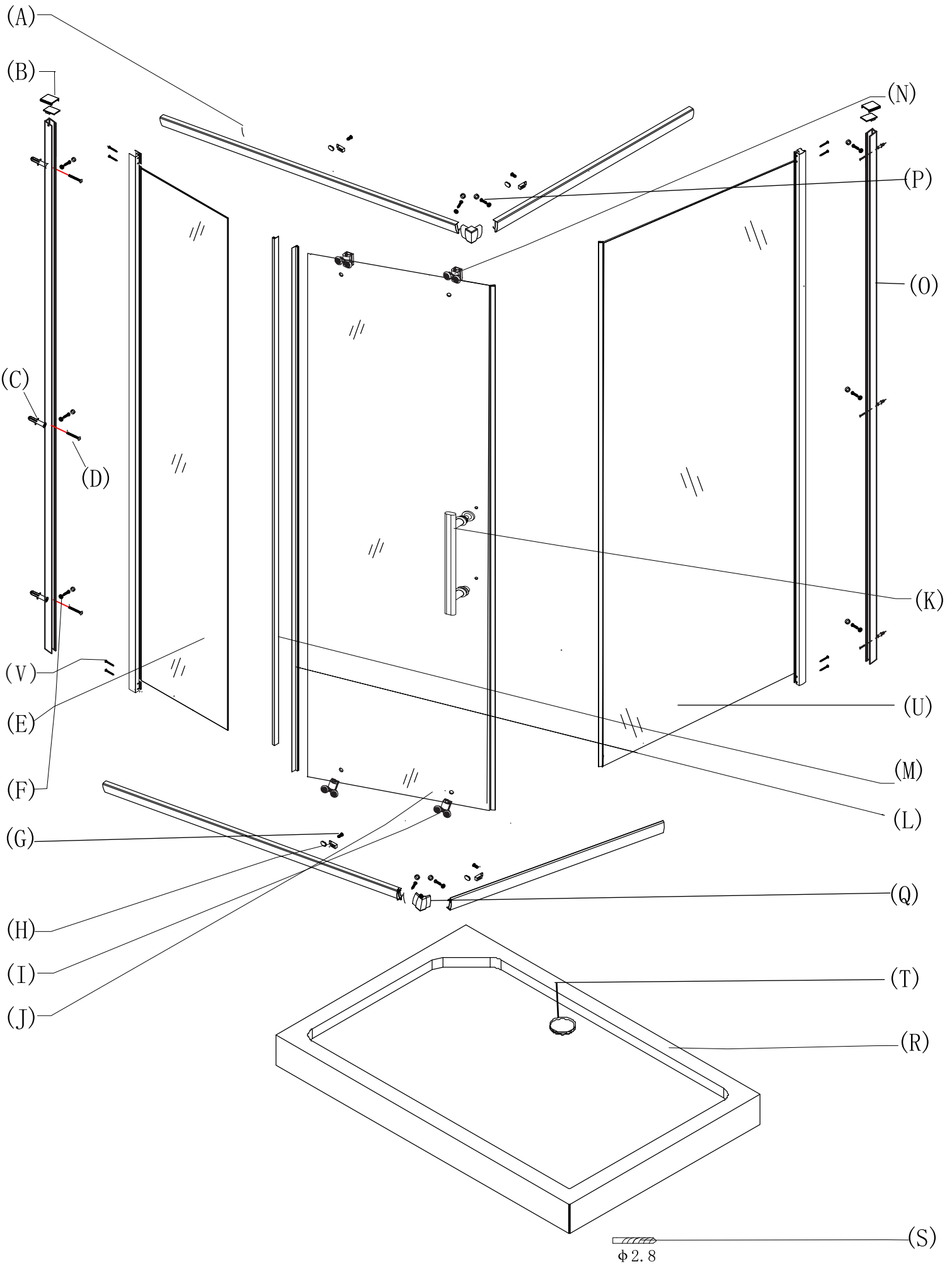









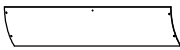



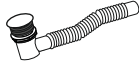



# Installation Manual



**MODEL: ESR-8022 / ESR-8021**

**SIZE: 800\*1000\*2000MM  
800\*1200\*2000MM**

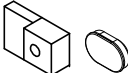
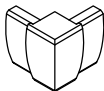

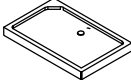
A		4	J		1	S	 φ 2.8	1
B		2	K		1	T		1
C		6	L		1	U		1
D	 ST4*30	6	M		1	V	 ST3.5*19	8
E		1	N		2			
F		10	O		2			
G	 ST4*10	10	P	 ST4*8	4			
H		4	Q		2			
I		2	R		1			

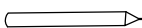
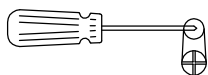
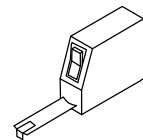
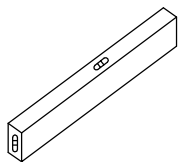

Ø6

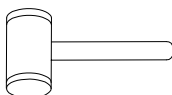

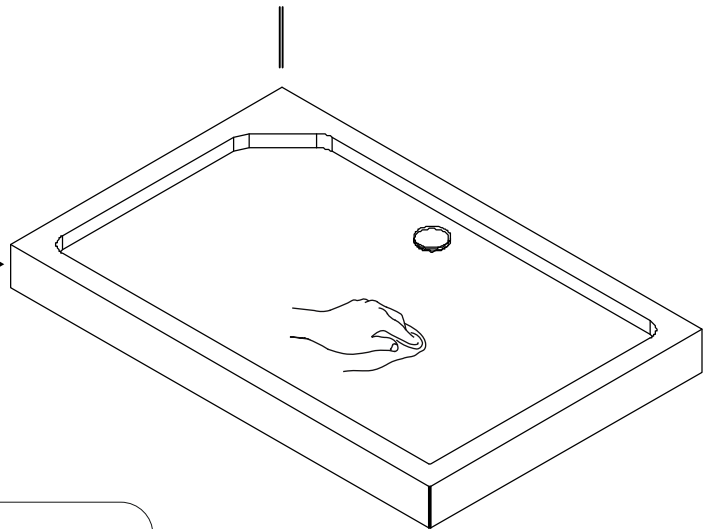
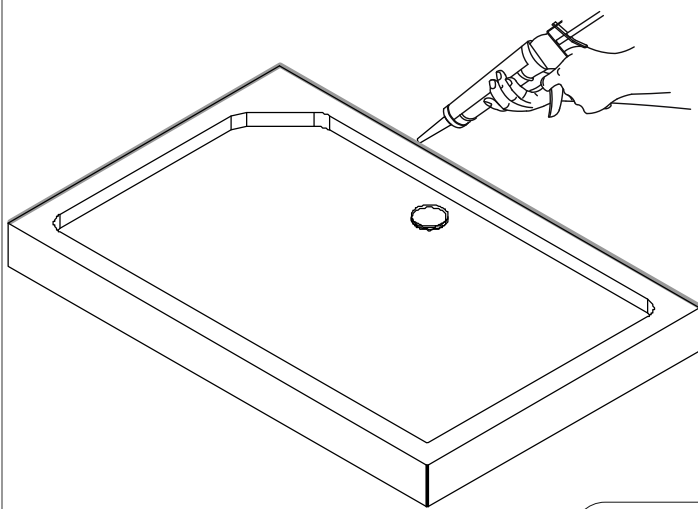
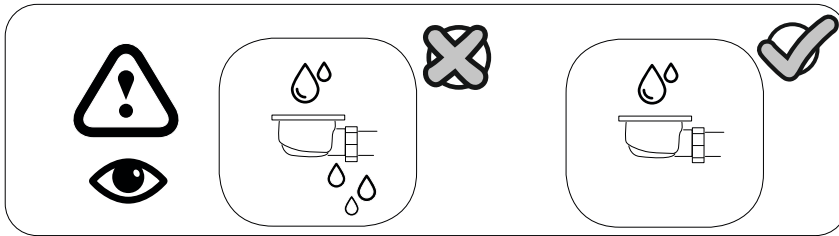
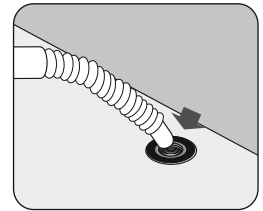
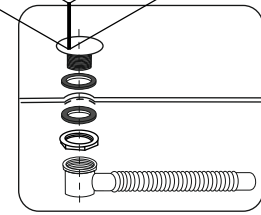
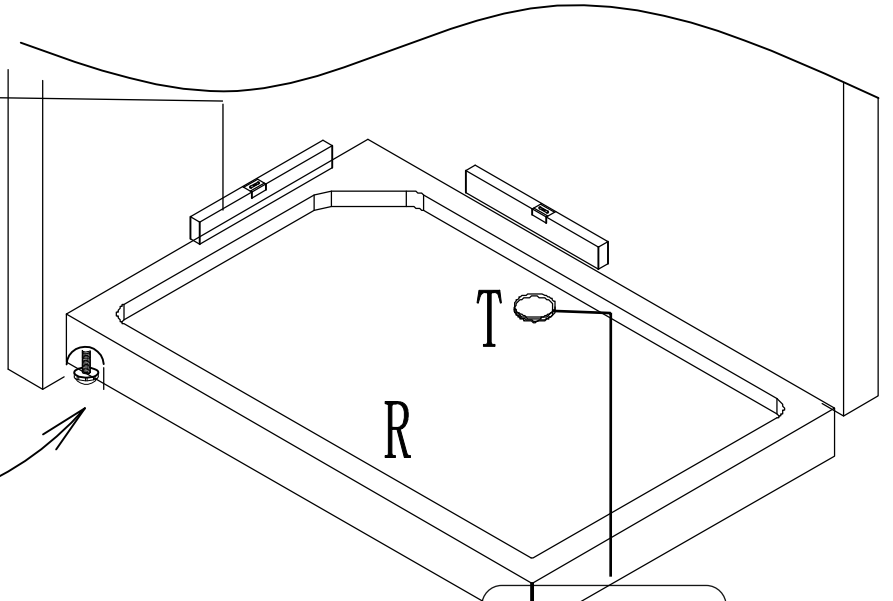
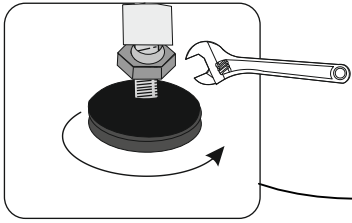
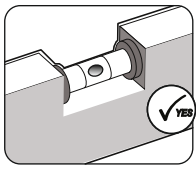

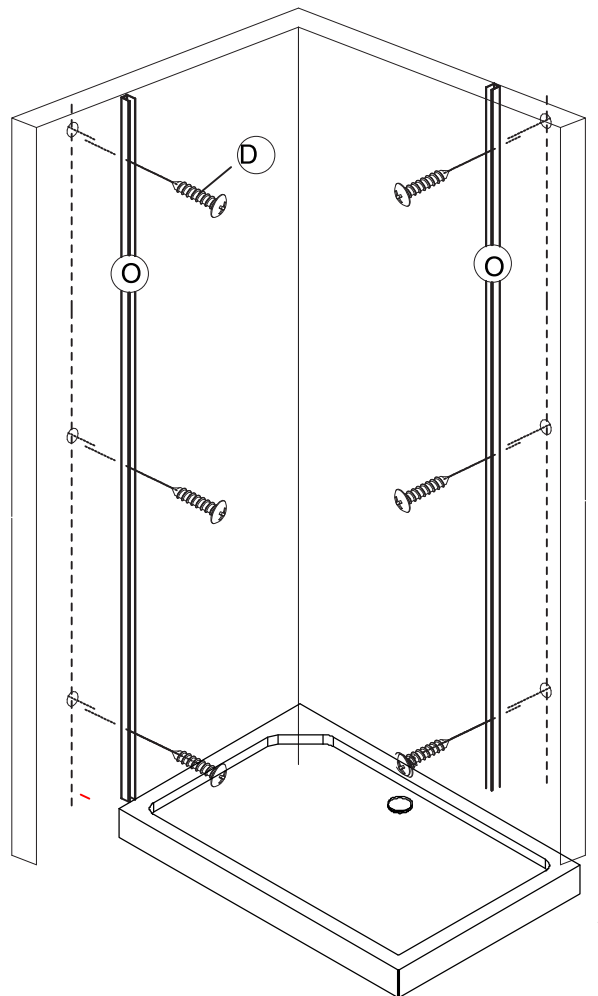
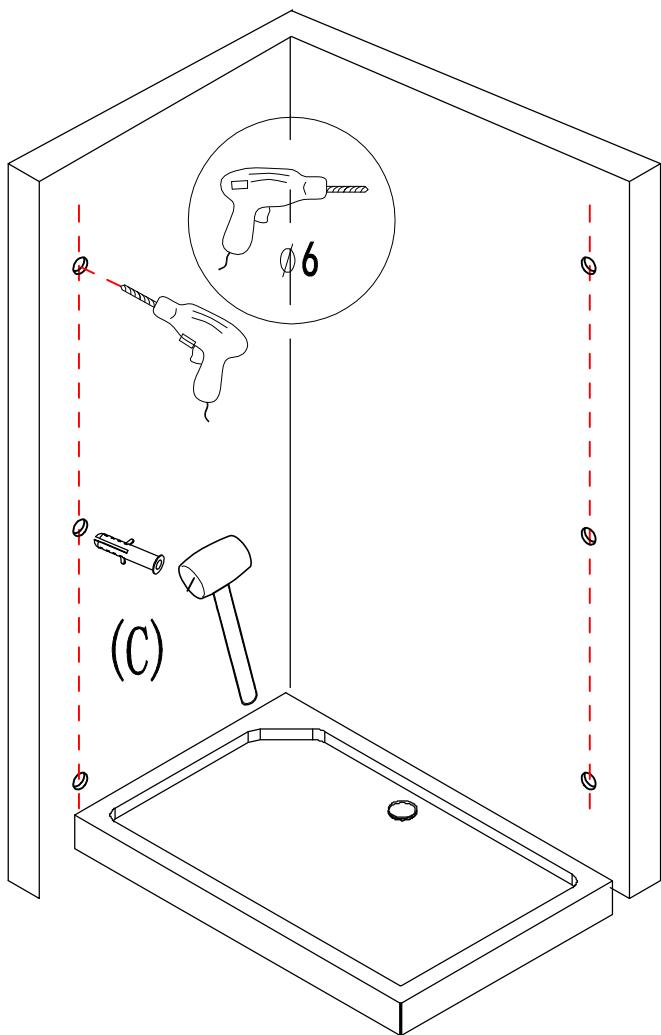
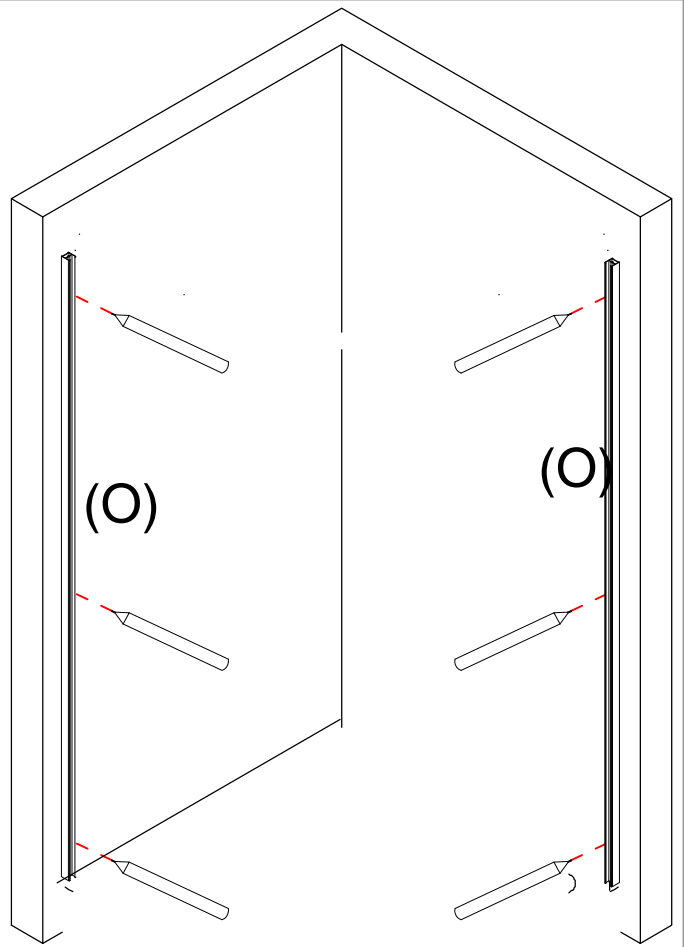
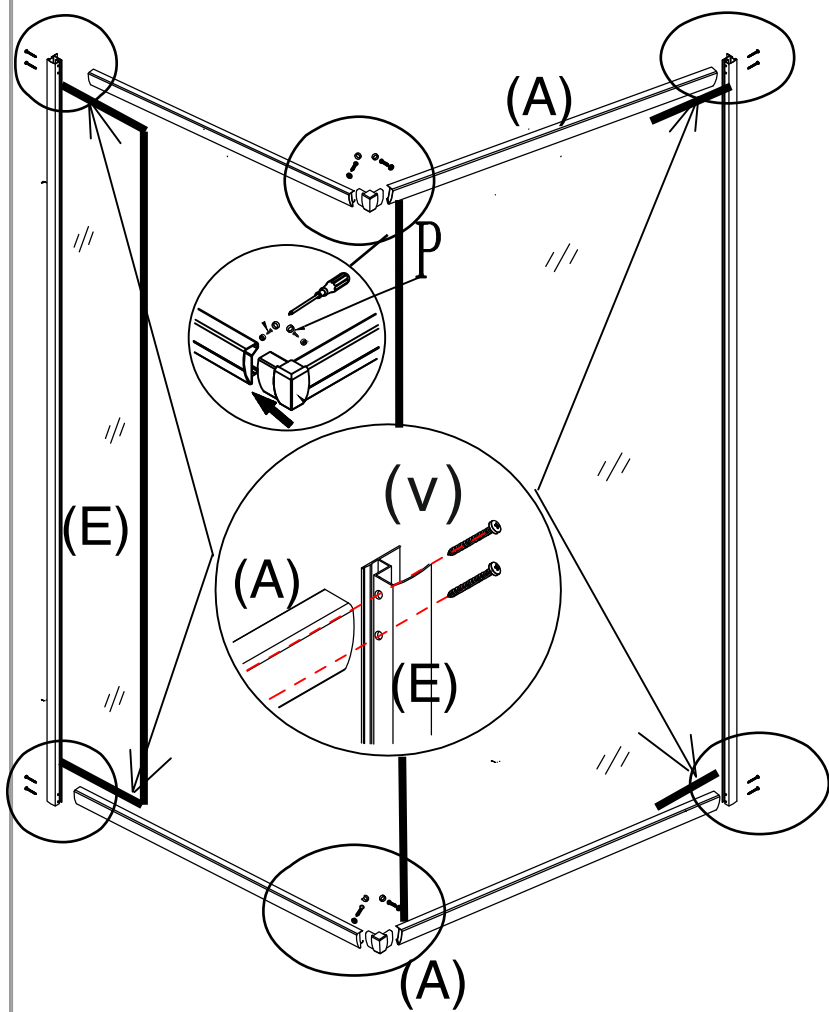

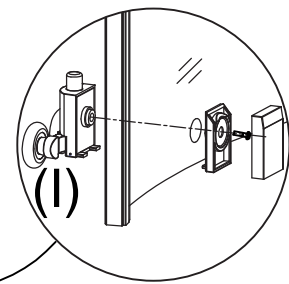
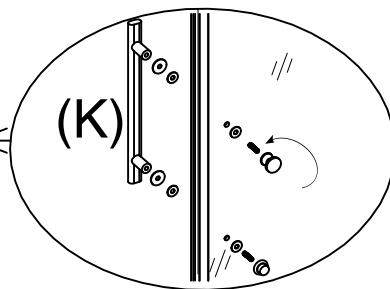
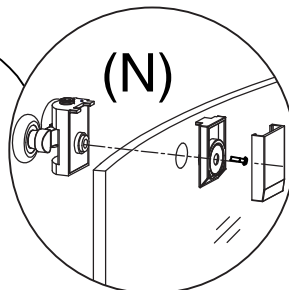
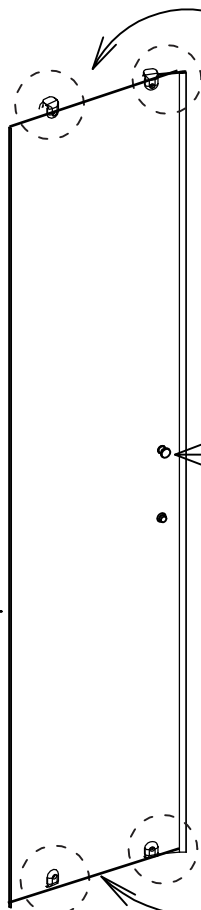
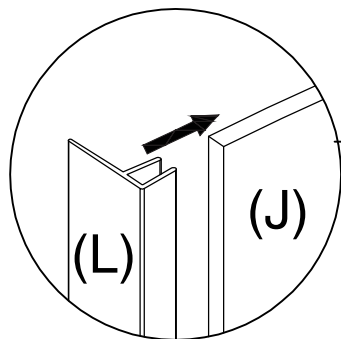
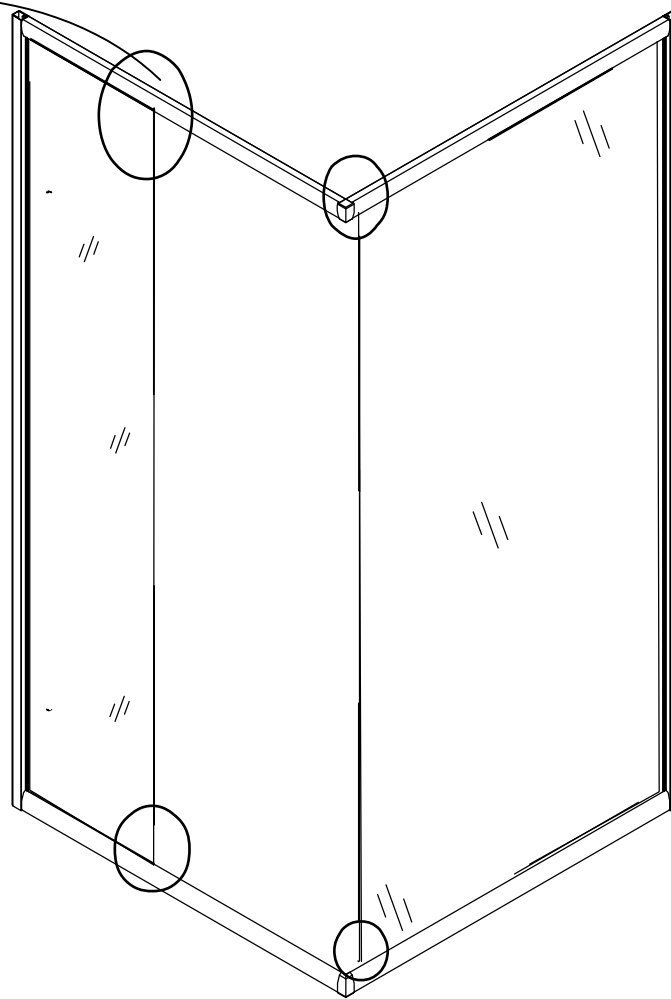
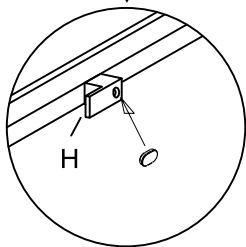
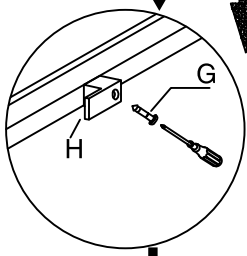
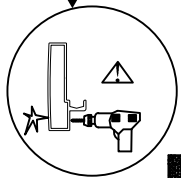
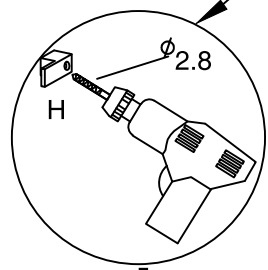

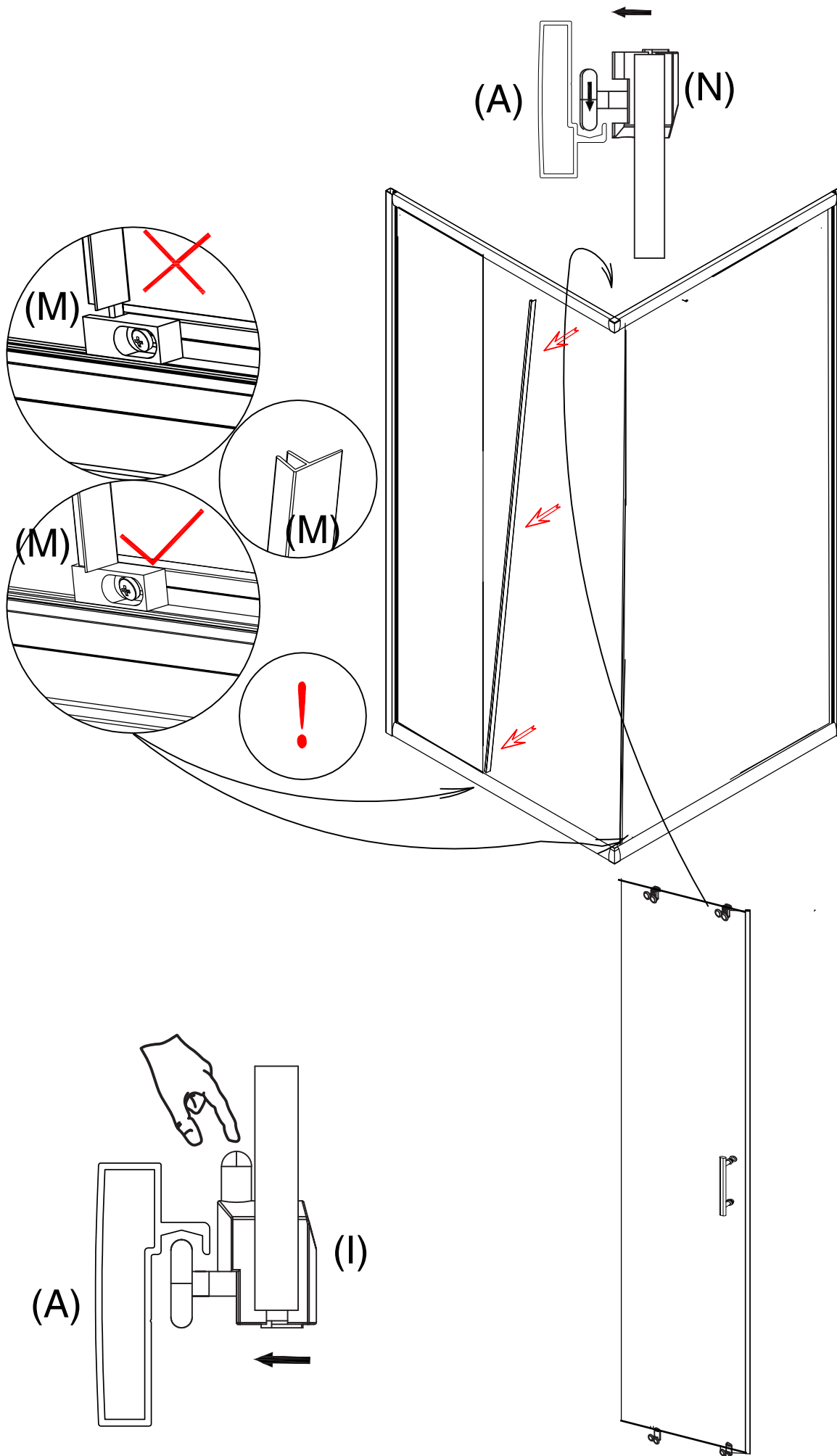

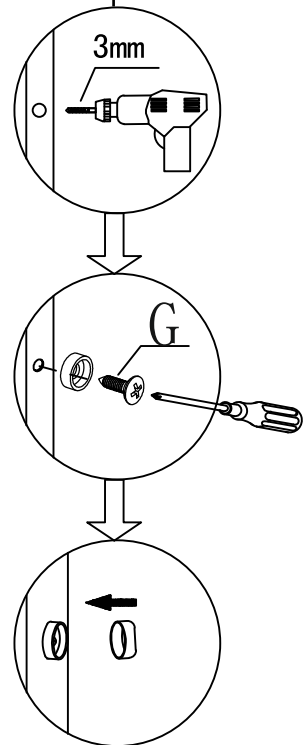
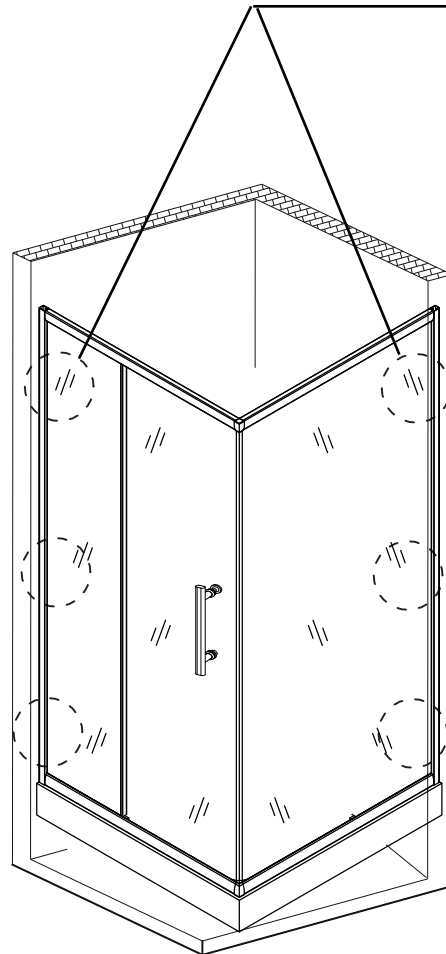
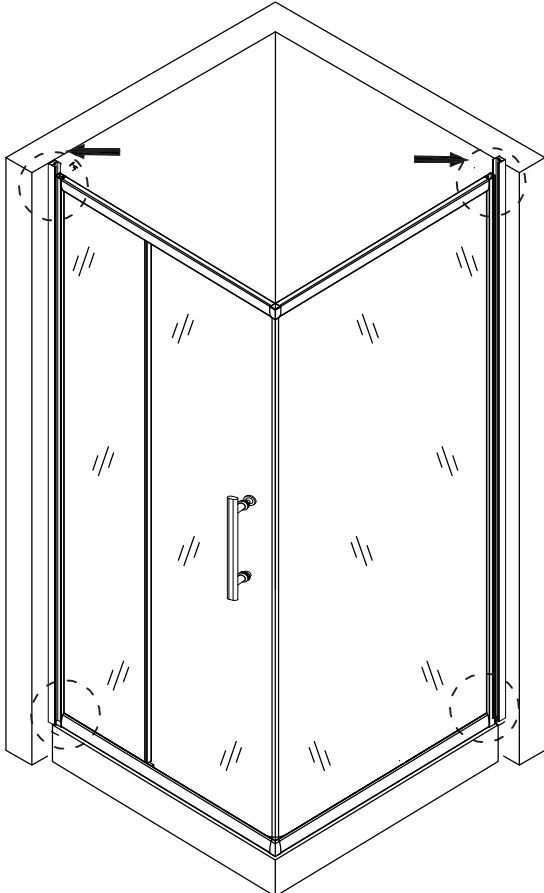
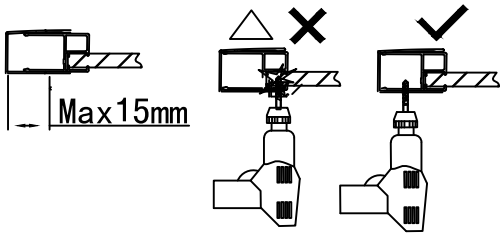
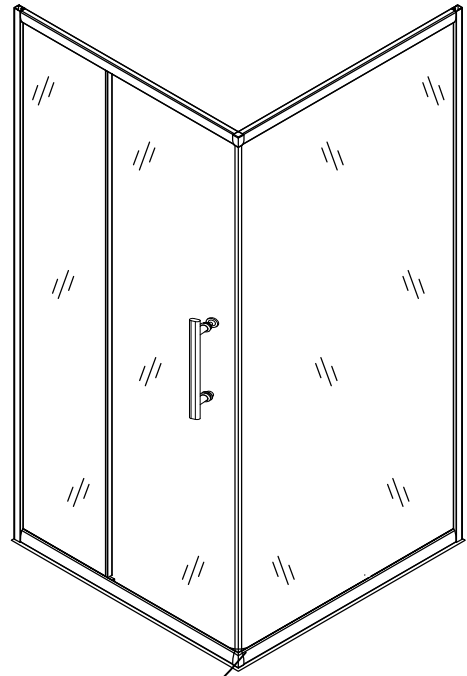
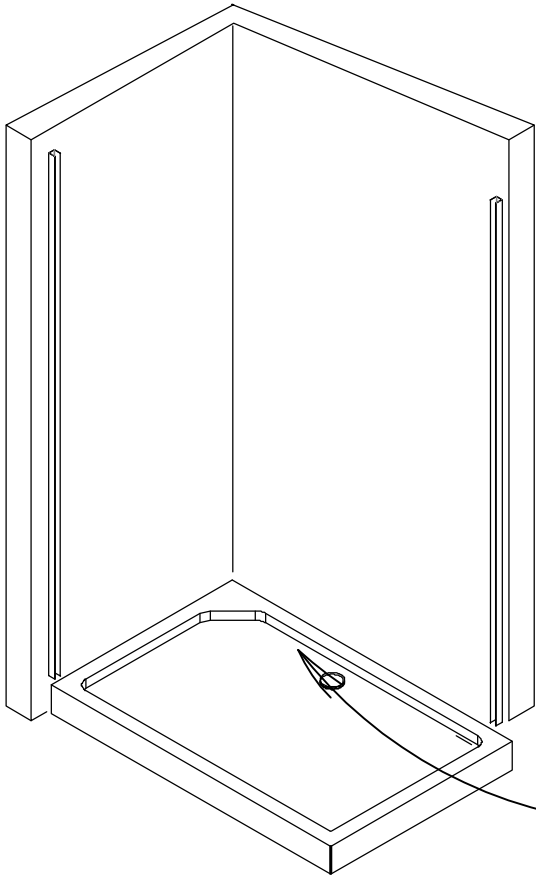



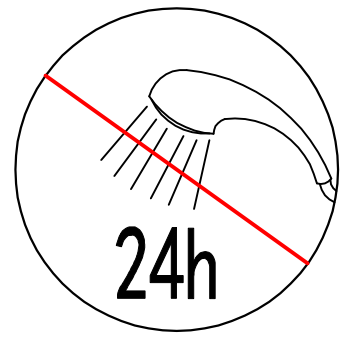
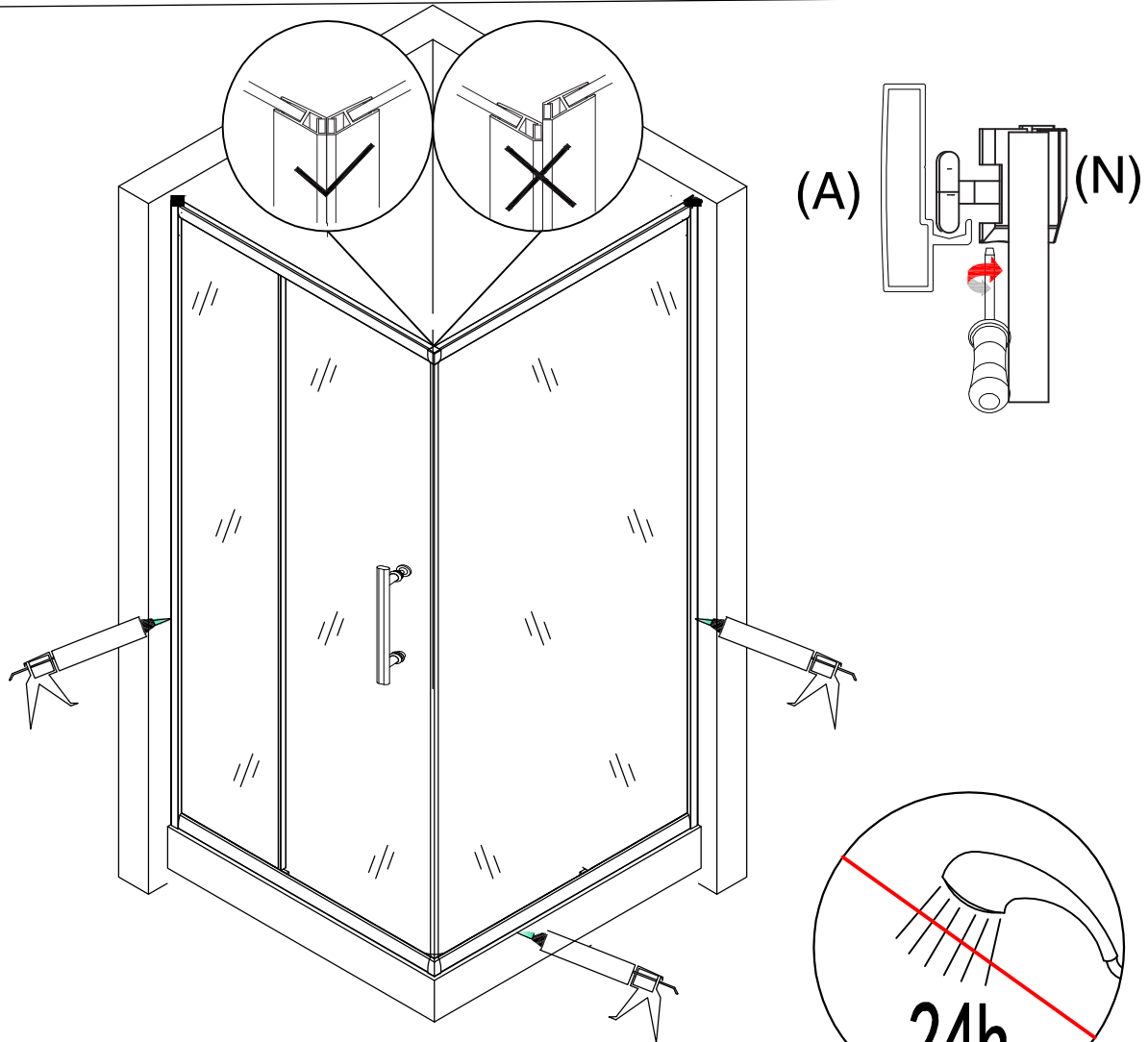
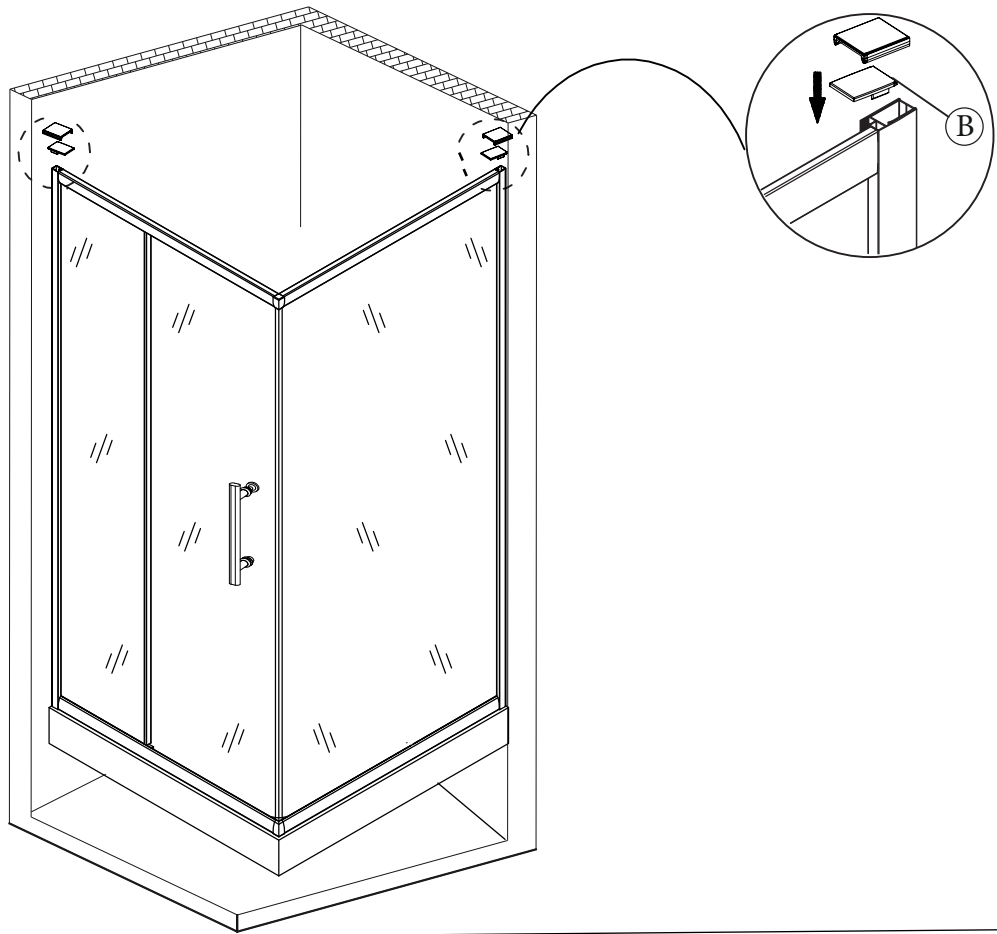

< 6 >