

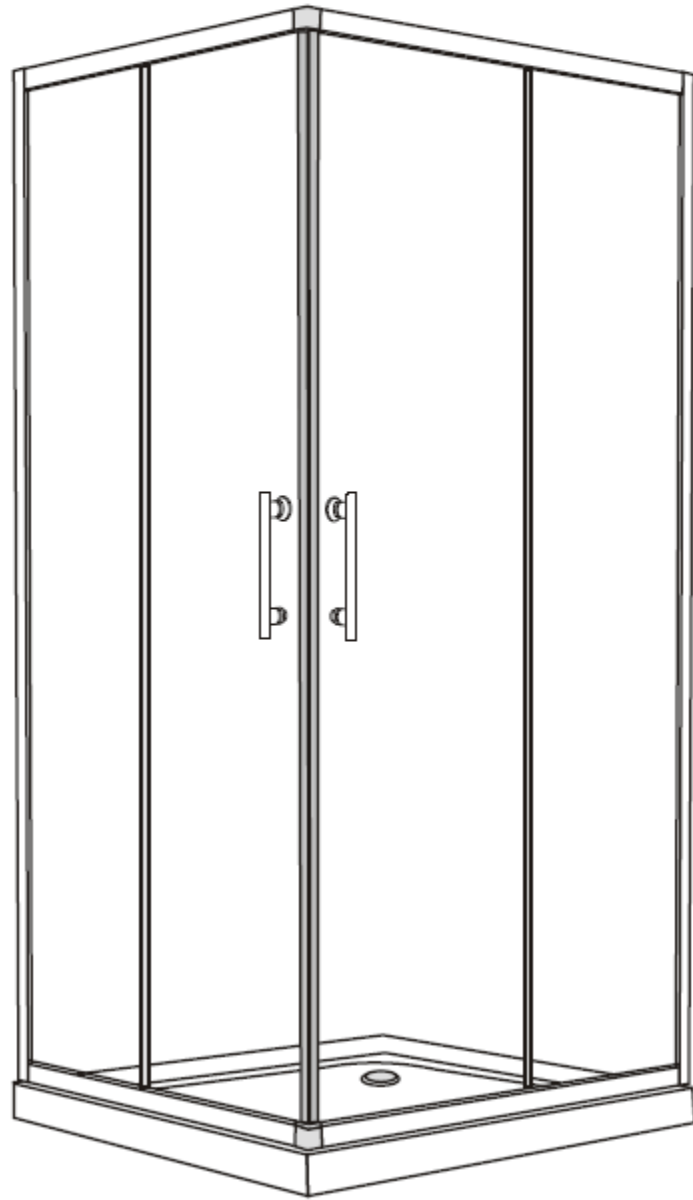

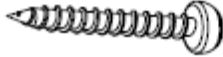











NG-008,009,010,012-14

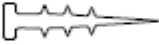

|    |  |           |     |
|----|--|-----------|-----|
| 1  |     | ST4X30    | X8  |
| 2  |     | Φ6x30     | X8  |
| 3  |     | ST3. 5x25 | X8  |
| 4  |     | ST4X12    | X10 |
| 5  |     | ST4X12    | X12 |
| 6  |     |           | X4  |
| 7  |  |           |     |
| 8  |    |           | X8  |
| 9  |   |           | X4  |
| 10 |   |           | X2  |
| 11 |   |           | X2  |
| 12 |   |           | X2  |
| 13 |   |           | X8  |
| 14 |  |           | X2  |
| 15 |   |           | X2  |

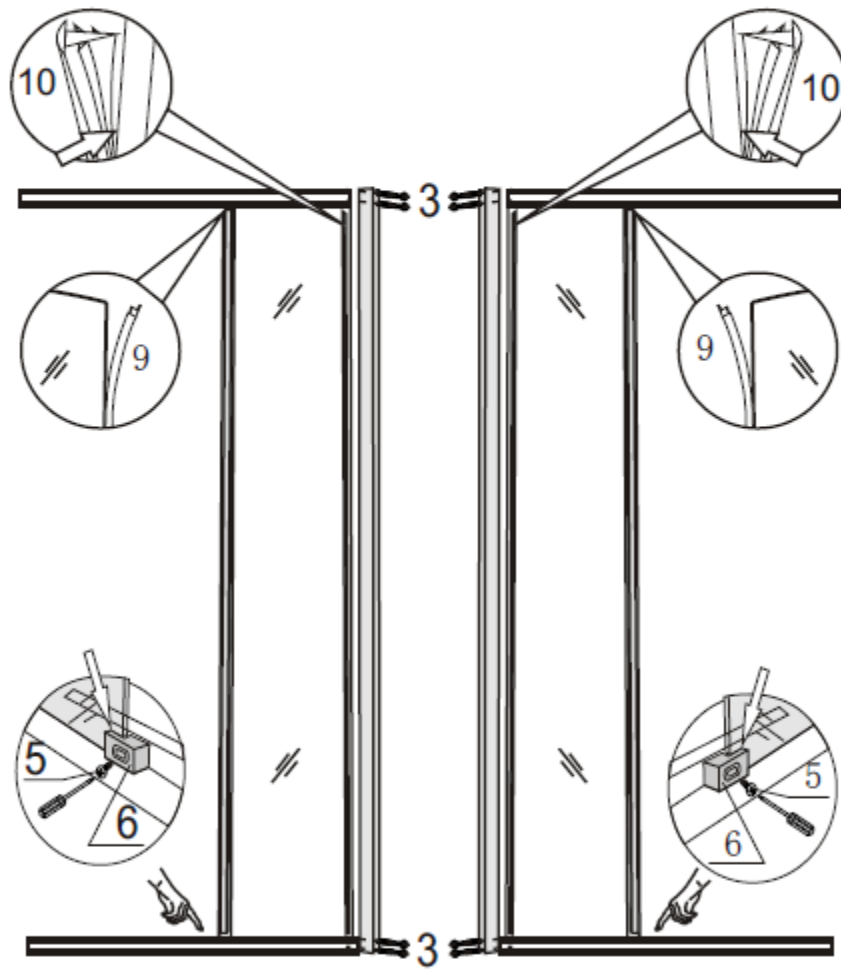
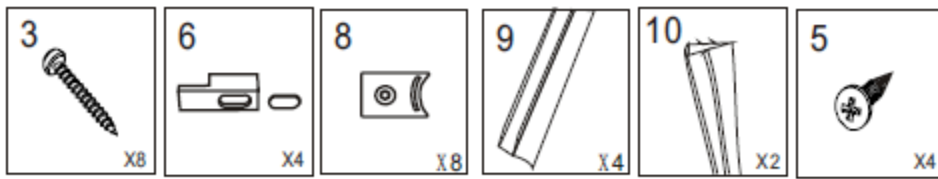

2

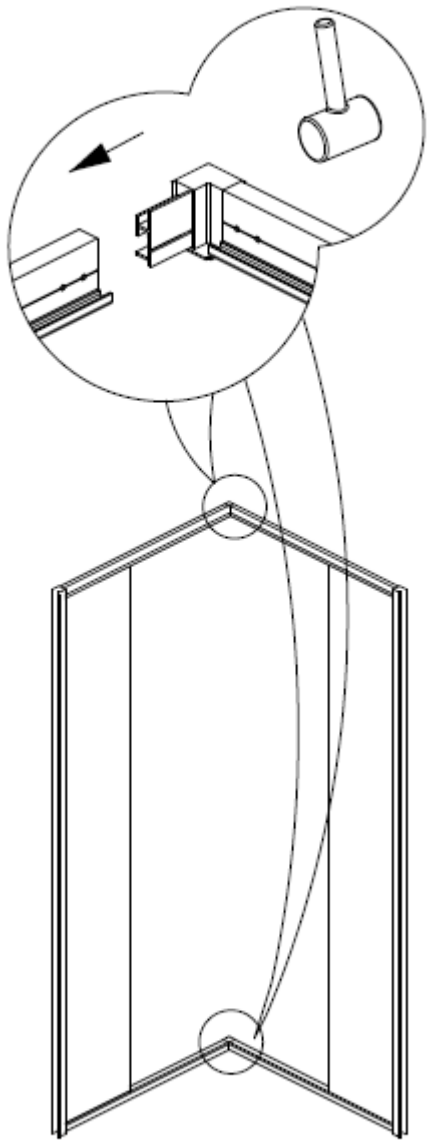

|             |                     |
|-------------|---------------------|
| <p>Ø3mm</p> | <p>4</p> <p>X4</p>  |
|             | <p>15</p> <p>X2</p> |

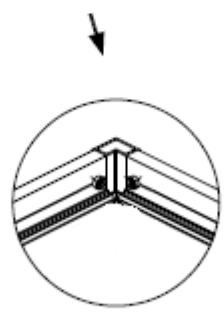
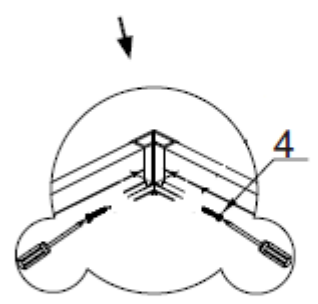
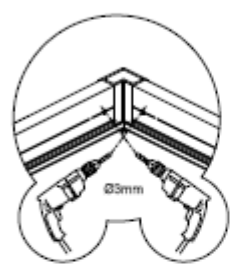

3

