

PREINSTALLATION
VORINSTALLATION

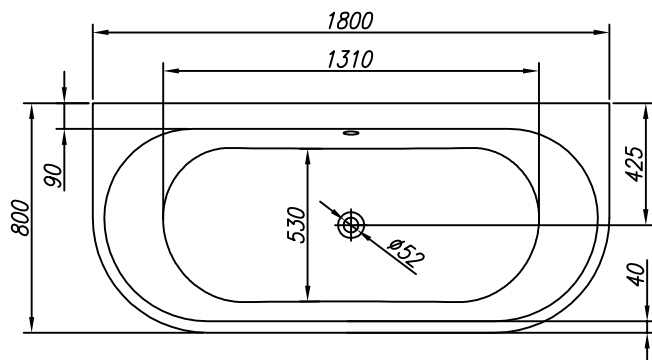

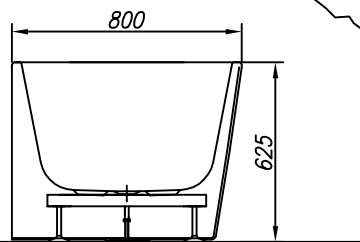

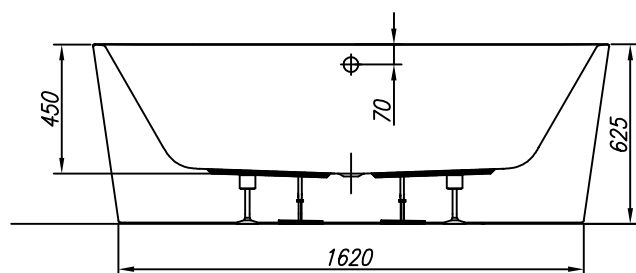
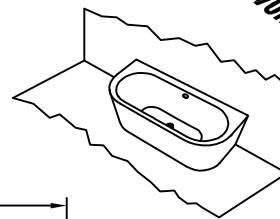

VOLUME (l)	MAX. LOAD (kg)	FLOOR LOAD (kg/m ²)
VOLUMEN (l)	MAX. BELASTUNG (kg)	BODENBELASTUNG (kg/m ²)

245

420

310

- 
 - Spot for el. cable 3×2.5mm², length approx. 1m
 - Platz Stromkabel 3 × 2,5 mm², Länge cca. 1 m
- 
 - Spot for el. cable 1×6mm² for earthing, length approx. 1.5m
 - Platz Stromkabel 1 × 6 mm² für Erdung, Länge cca. 1,5 m
- 
 - Connection of hot and cold water 1/2" min 0.2Mpa, max 0.4Mpa
 - Anschluss Warm- und Kaltwasser 1/2" min 0,2 Mpa, max 0,4 Mpa
- 
 - Drain spot Ø 50mm
 - Abflussplatz Ø 50 mm



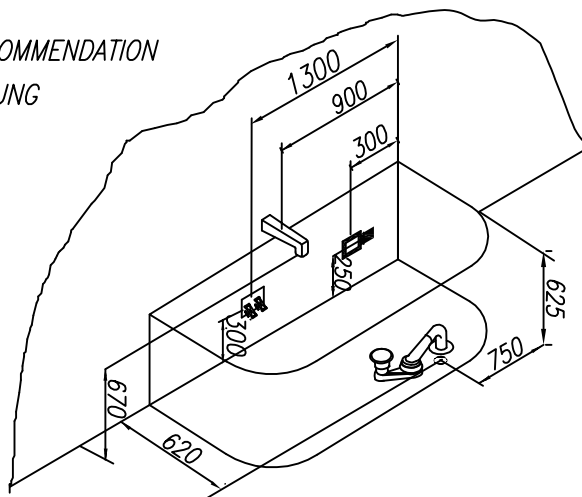





INSTALLATION RECOMMENDATION
MONTAGEEMPFEHLUNG



DREAM-SP 180x80

POSITION OF SWITCHES AND GENERATORS IN DIFFERENT VERSIONS OF MASSAGE SYSTEMS

POSITION SCHALTER UND AGGREGATE BEI VERSCHIEDENEN AUSFÜHRUNGEN VON MASSAGESYSTEMEN

- PUMP  - WATER JETS  - AIR CONTROLLER  - ELECTRONIC SWITCHES  - WASSERHAHN UND DUSCHE
- WASSERPUMPE - WASSERDÜSEN - LUFTREGLER - ELEKTROSCHALTER
-  - AIR PUMP  - AIR JET  - PNEUMATIC SWITCH  - LIGHT OR CHROMOTHERAPY  - MICROJET SWITCH
- LUFTPUMPE - LUFTDÜSE - PNEUMATIKSCHALTER - LICHT- ODER CHROMOTHERAPIE - SCHALTER FÜR MIKRODÜSEN

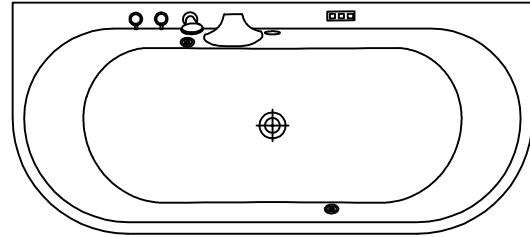
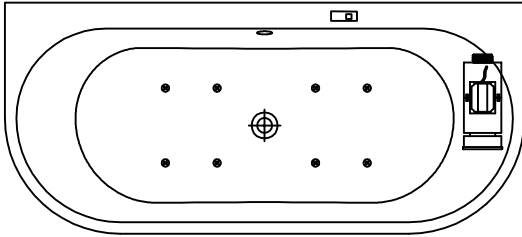

AIR MESSAGE SYSTEM

- BLOWER P=800W
- ELECTRONIC SWITCH
- 8 AIR JETS

LUFTMASSAGESYSTEM

- LUFTPUMPE P = 800 W
- ELEKTROSCHALTER
- 8 LUFTDÜSEN

- OPTION FIXTURE AND SHOWER HANDLE - MÖGLICHKEIT WASSERHAHN UND DUSCHE

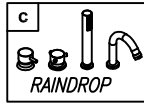
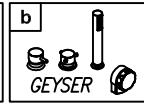
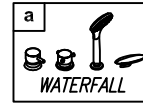
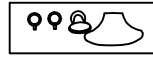

- OPTION CHROMOTHERAPY



- MÖGLICHKEIT CHROMOTHERAPIE